



It's Time to Keep the Lights On at Large Venue

- Up to 7000AL Brightness
- 1.6x big zoom and vertical lens shift to ease installation
- H/V keystone and corner fit to adapt to any integration constraint
- Large choice of input connections (2xHDMI, VGA IN/OUT...)
- 3D ready
- LAN control/MHL/HDMI with powered USB
- Energy saving: auto power off, Eco blank, 0.5W standby power consumption
- 6 segment color wheel for better color reproduction
- 10W x2 speakers with powerful sound
- User memory settings for personalised image



HDMITM
HIGH DEFINITION MULTIMEDIA INTERFACE



Extron



SX930 7000AL XGA DLP Projector
SU931 6000AL WUXGA DLP Projector

BenQ

Because it matters

Exceptional Image Quality for High-Impact Presentations

Superior Image Quality

With up to 7000 ANSI Lumens, this new S9 series will always give you the best clarity under bright environment conditions. So, take advantage! Stay in control and enjoy perfect presentations and the best interactions with your audience; moreover, the combined expertise of BenQ's projector know-hows delivers an outstanding 5000:1 contrast ratio at the highest to significantly improve the black level for superbly rendered image definition.



High Contrast



Low Contrast

Perfect Six-Color Management via Independent 3D Calibration

Independently fine-tune the hue, gain, and saturation levels of each of the six primary colors (R/G/B/C/M/Y) with innovative BenQ 3D color management. The ability to precisely control these parameters greatly enhances mid-tones and greyscales to deliver more realistic images and video.

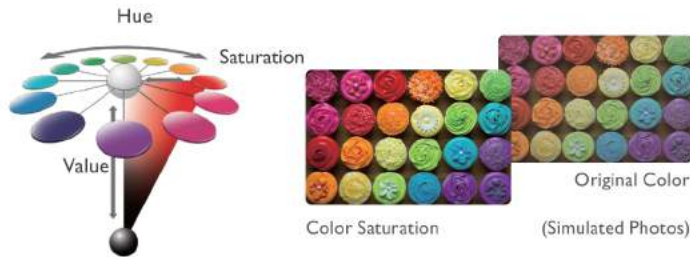

Long-Lasting DLP Image Perfection

Utilizing a nearly-sealed DLP projection engine, BenQ projectors exhibit virtually no image distortion from panel aging due to heat or dust buildup. Millions of micro mirrors on the advanced DMD chip reflect pure light through the color wheel, producing precise details and intensely saturated colors without degradation over time.



Blu-ray Full HD 3D Supported

BenQ SX930/SU931 is built with latest DLP® technology to support 3D functionality, allowing schools to bring an immersive learning experience to their students with a simple preparation of 3D glasses and 3D content.



Installation Flexibility

Big Zoom for Extra Projector Installation Flexibility

1.6x big zoom feature opens up space with an impressively wide range of throw distances. All you have to do is simply place the new projector right where your original ceiling mount is. Without adding projector setting re-construction costs to your budget list, you'll get to save the money for better use.



Vertical lens shift for Extra room for minor miscalculations

The SX930/SU931 vertical lens shift feature allows you to adjust the vertical projection area and have less sacrifice on image quality.

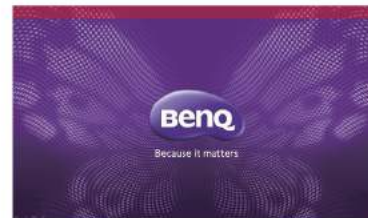

Vertical Lens Shift
SX930: +5.0%
SU931: +2.5%

2D Keystone Correction & Corner Fit Correction

When the projector is placed off-center, the 2D keystone correction feature gives you a wider projector installation flexibility by correcting the trapezoid effect using horizontal and vertical adjustments. Moreover, corner Fit is a flexible and convenient way to correct picture dimensions by adjusting each corner of an image independently.

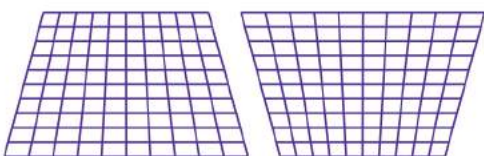

Vertical Keystone

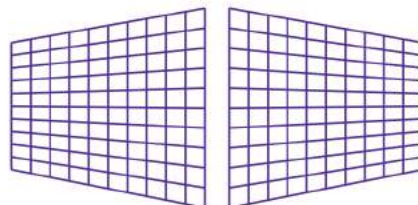

Horizontal Keystone

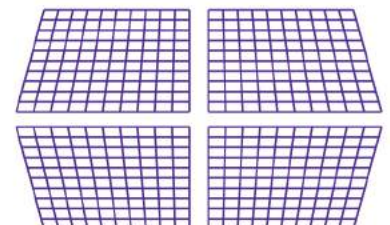

Corner Fit

Ease of Operation

LAN Control

Designed to help IT managers perform day-to-day projector maintenance efficiently, LAN Control provides full access and control over networked projectors directly from IT workstations. The interface offers seamless support for Crestron, RoomView and PJ-Link LAN control systems.



MHL Connectivity

MHL connectivity allows you to share your audiovisual content from mobile devices on the big screen through MHL cable or dongle. Also, your device or dongle is charged while you're projecting from it, so you don't have to worry about battery life while presenting.



Upper Lamp Door

A quick-release lamp door offers easy lamp access without removing the projector from ceiling-mounted installations.



Powered USB

The USB port supplies power for wireless dongles to provide uninterrupted viewing.

Unique Features for Meeting Rooms

Built-in 10W Speaker Power

The SX930/SU931 comes with enhanced audio support for your meetingroom, delivering crisp-clear audio performance with built-in 10W speaker power. Now, teachers can teach with ease and students can learn more effectively.



Microphone Input Support

With the microphone input, teachers get to reach every student with straining their voice. All they need to do is plug in the microphone or microphone headset to get started! The built-in speaker will do the rest!



Dimension

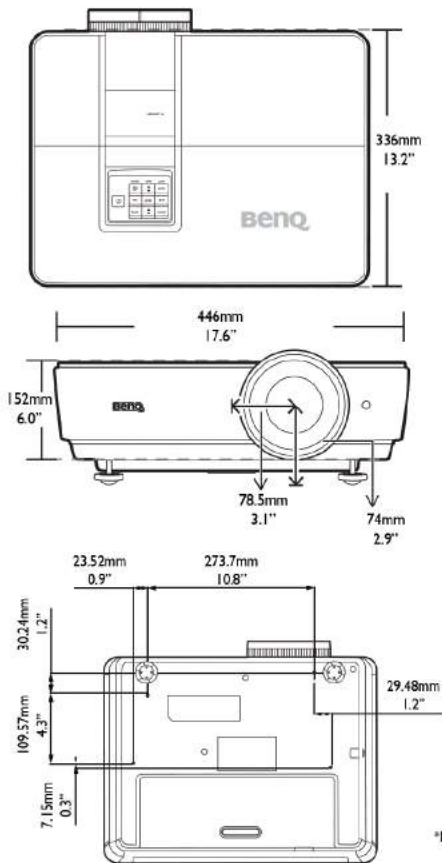

Specification

	SX930	SU931
Projection System	DLP™	DLP™
Color Wheel	6 seg (RGBYCW)	6 seg (RGBYCW)
Native Resolution	XGA (1024x768)	WUXGA (1920x1200)
Brightness	7000 ANSI Lumens	6000 ANSI Lumens
Contrast Ratio	2500:1	3000:1
Display Color	1.07 Billion Colors	
Lens	F= 2.1~2.63, f=21.7~34.64mm	F= 2.45~3.07, f=15.78~25.12mm
Aspect Ratio	4:3	16:10
Throw Ratio	1.5-2.4:1	1.07-1.71:1
Maximum Image Size (Diagonal)	300"	
Zoom Ratio	x1.6	
Lamp Wattage	465W	
Lamp(Normal/Eco Mode)	2000h/2500h	
Keystone Adjustment	V&H: +/-30°	
Projection Offset	107.5%±2.5%	102.5%±2.5%
Lens Shift	Vertical: +5%	Vertical: +2.5%
PC Signal Compatibility	up to WUXGA (1920x1200)	
HDTV Compatibility	480i, 480p, 576i, 576p, 720p, 1080i, 1080p	
Video Compatibility	NTSC, PAL, SECAM	
Horizontal Frequency	15~102KHz	
Dimensions(W x H x D)	446 x 152 x 336 mm	
Weight	6.7kg	
Audible Noise (normal/eco)	39/36dBA	
Power Supply	AC 100 to 240 V, 50/60 Hz	
Power Consumption	620W	
Standby power consumption	<0.5W	
Operating environment	0~40°C / 10%~90% humidity w/ no condensation	
What's in the box	remote control w/ battery, power cord, user manual CD, quick start guide, VGA cable, lens cover	

*Lamp life results will vary depending on environmental conditions and usage. Actual product's features and specifications are subject to change without notice.

Input and Output Terminals

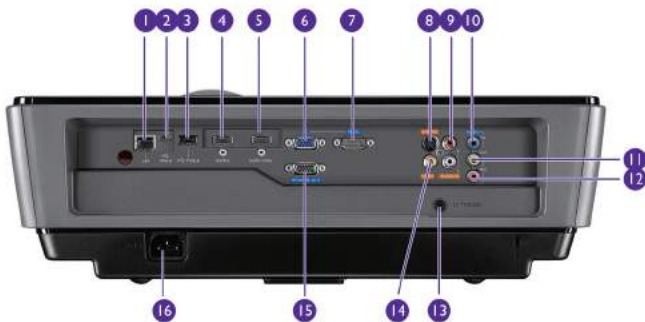

- 1- RJ45 LAN input (control)
- 2- USB Mini B type port
- 3- USB A type port
- 4- HDMI 2 input
- 5- HDMI 1 / MHL input
- 6- RGB input
- 7- RS232 input
- 8- S-Video input
- 9- Audio (L/R) input
- 10- Audio input
- 11- Audio output
- 12- Mic input
- 13- DC 12V trigger
- 14- VIDEO input
- 15- RGB signal output
- 16- Power cord inlet

Optional accessory

Universal ceiling mount
- CM00G3 (5J,JAM10.001)



Active 3D glasses
- DGDS (5J,J9H25.001)



Spare lamp kit
- SX930: (5J,JEG05.001)



- SU931: (5J,JEH05.001)



Key Features

- Horizontal & Vertical keystone
- Corner fit
- Compatible with PjLink
- Compatible with Crestron
- Compatible with AMX
- Compatible with Extron
- Auto power off
- VGA signal power on
- Direct power on
- User memory setting
- Support all 3D mandatory formats
- Standby power <0.5W (network off)
- Eco Blank mode
- Teaching templates
- RoHS compliant
- Quick auto source search
- Closed captioning
- Panel key lock
- Kensington lock / security bar
- Variable audio out
- Top access lamp door

BenQ Europe B.V.

Meerenakkerweg 1-17
5652 AR Eindhoven
The Netherlands
Tel: +31 88 888 9200
Fax: +31 88 888 9299

